

手持式检漏仪

Handheld Leak Detector



HD-821 系列

Series

- 内置电池，手持便携
- 一机多用，示踪气体多样（氢气、一氧化碳、乙醇、异丁烷）
- 探头、显示及按键一体，单手可操作
- 待机快捷唤醒，检测无需等待
- 探头可随意弯曲定型
- 可选WiFi通讯功能，可计算机或手机App无线操控



- Built-in battery, portable
- Multi-function, applicable for various tracer gas (Hydrogen, Carbon monoxide, Ethanol, Isobutane)
- Integrated probe, display and buttons, one-handed operation
- Quick wake-up, can be used immediately with no need to wait
- Flexible probe
- Optional WiFi communication function, wireless control

探头 Probe

气体采样感应，吸入流量
可调节大小
Gas sampling induction, the
amount of inhaled gas can
be adjusted

照明灯 Floodlight

便于黑暗环境操作
Easy to operate in dark environment

报警灯 Alarm Lamp

绿：正常工作，结果OK
Green: Normal operation, result OK
红：结果NG
Red: Result NG
蓝：进入参数设定状态
Blue: Enter the parameter setting state



OLED彩屏 OLED Color Display

显示检测数据
Display Test Data

设定按键 Setting Button

参数设置及功能选择
Parameter setting and function
selection



定量检测/定位显示同步进行式 Quantitative Detection /Location Detection can work on simultaneously

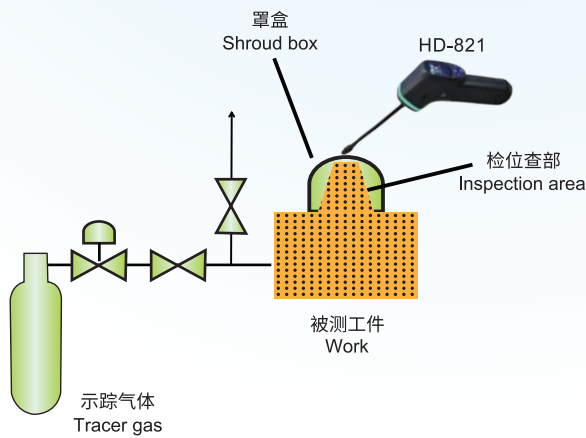



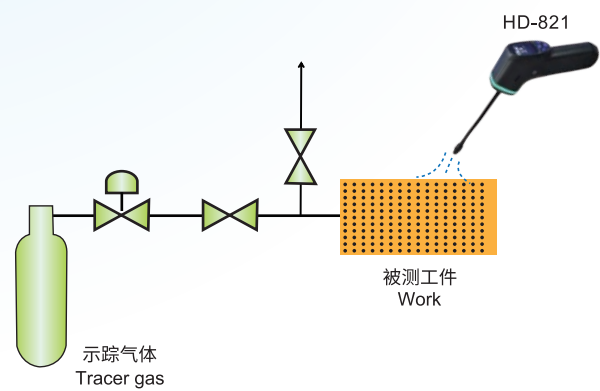

- 使用罩盒，对关键部位精确测量
Use the shroud box to accurately measure the key parts

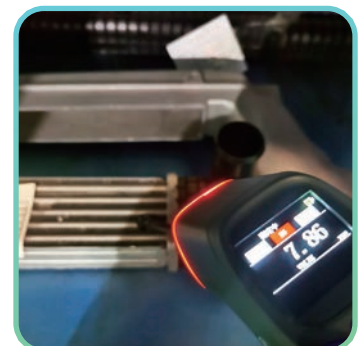

- 直接吸扫被测物，查找漏点
Directly aim at the measured object to find the leakage point



外置选购品 (需单独购买) External Options (to be purchased separately)

标准漏孔 Standard Leak: FFM-110-B112 	压力范围 Pressure Range	-0.1MPa ~ 2.0MPa任意指定 Specified freely
	漏率范围 Leak Rate Range	$10^{-4} \sim 10^{-7} \text{Pa}\cdot\text{m}^3/\text{s}$
	外形尺寸 Dimensions	$\phi 17 \times 74\text{mm}$
标准漏孔 Standard Leak: FFM-2100-B002 	压力范围 Pressure Range	-0.1MPa~1.0MPa
	漏率范围 Leak Rate Range	$10^{-4} \sim 10^{-7} \text{Pa}\cdot\text{m}^3/\text{s}$
	外形尺寸 Dimensions	$\phi 45 \times 330\text{mm}$
充排气控制装置 Charge/Exhaust Controlling Unit CEU-1/CEU-5 	压力范围 Pressure Range	-0.1 ~ 1.0MPa -0.1 ~ 5.0MPa
	外形尺寸 Dimensions	342.6W × 193.5H × 361D (mm)
充排气控制装置 Charge/Exhaust Controlling Unit CEU-B 	压力范围 Pressure Range	-0.1 ~ 1.0MPa
	外形尺寸 Dimensions	202W × 240H × 336D(mm)

标准漏孔为必须配备产品,漏孔形式可根据客户要求选择。充排气控制装置根据客户现场情况选择型号,如被测物内部已经充有示踪气体,则无需选择该装置。

Equiped with leak standard, you can choose it's form according to your request. You could choose the model of intake and exhaust control device according to the site. If the work charged with tracer gas, the control device is not needed.

规格 Specification

测定方式 Measuring method	吸入式, 定量检测/定位显示同步进行式 Quantitative detection (inhalation) / Location detection can work on simultaneously
最小可检漏率 Minimum detectable leak rate	H ₂ 氢气浓度: 0.1mL/m ³ (ppm) H ₂ hydrogen concentration: 0.1mL/m ³ (ppm) 漏率: $1 \times 10^{-7} \text{Pa}\cdot\text{m}^3/\text{s}$ (5%氢气+95%氮气) Leakage rate: $1 \times 10^{-7} \text{Pa}\cdot\text{m}^3/\text{s}$ (5% hydrogen + 95% nitrogen)
使用方式 Usage mode	手持式 Handheld
示踪气体 Tracer gas	氢气、一氧化碳、乙醇、异丁烷 Hydrogen, Carbon monoxide, Ethanol, Isobutane
分辨率 Definition	0.01mL/m ³ (ppm)
浓度范围 Concentration range	0~1000mL/m ³ (ppm)
吸气量 Amount of gas inhaled	0~100mL/min (200mm金属管 metal hose), 0~40mL/min (400mm金属管 metal hose)
单位切换 Unit switchover	mL/m ³ 、ppm、Pa·m ³ /s、mL/sec、mL/min、g/year、mbar·L/s、Torr·L/s
显示方式 Display mode	OLED 彩屏 Color display
使用温度范围 Operating temperature range	5~40 °C
使用湿度范围 Operating humidity range	45~85%RH, 无结露 45-85% RH, no condensation
电源需求 Power Requirement	充电器: 100~240V AC, 50/60Hz Charger: 100-240V AC, 50 / 60Hz 锂电池: 26650 (带保护板) 2.7~4.2V DC Lithium battery: 26650(with protection board) 2.7-4.2V DC
电池供电 Battery powered	USB口可充电, 连续使用时间≥8小时 (标准使用状态) Rechargeable USB port, continuous use time ≥8 hours (standard status)
重量 Weight	约 0.4kg (200mm金属管, 含电池) / 0.5kg (400mm金属管, 含电池) Approx. 0.4kg (metal hose 200mm, including battery) / 0.5kg (metal hose 400mm, including battery)

产品选型 Product model selection

HD-821-①②③④

①量程 Measurement range

记号	说明
1	氢气传感器范围 Sensor detection range: 0~1000mL/m ³ (ppm, 百万分之一), 最小分辨率 Minimum resolution: 0.01mL/m ³

※如需其他示踪气体, 请与我们联系, If you want other tracer gas, please contact us

②电池 Battery

记号	说明
N	不带锂电池, 适用于航空运输, Without lithium battery, suitable for foreign air transportation
2	标配2个锂电池 (一个使用, 另一个可充电) 2 lithium batteries as standard (alternate charging)

※如用户自配锂电池, 电池型号: 26650 (带保护板, $\phi 26.5\text{mm}$, 高70mm) Such as self-provided lithium battery, model: 26650 (with protection board $\phi 26.5\text{mm}$, height 70mm)

③金属软管长度 Length of metal hose

记号	说明
1	200mm (不含传感器头) Excluding sensor head
2	400mm (不含传感器头) Excluding sensor head

④无线通讯 Wireless communication

记号	说明
N	无此功能 No such function
1	内置WiFi通讯功能, 可连接手机APP或计算机软件 Built-in wifi communication for connections with mobile APP (Andriod) or computer software

可与手机APP\上位机通讯 Communicating with mobile phone APP/PC



APP界面



PC界面

无线通讯距离：无阻挡5米，如需更长距离可通过无线路由器实现。

Wireless communication distance: 5 meters in the case of no blocking, if more distance is needed, it can be realized through wireless router.

外形尺寸 Dimensions(mm)

HD-821 手持式检漏仪
Handheld leak detector

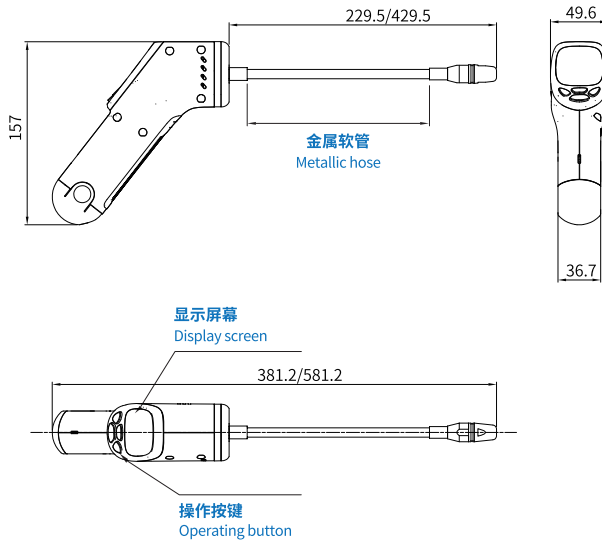

CEU-B 充排气控制装置 (选购)
Handheld leak detector

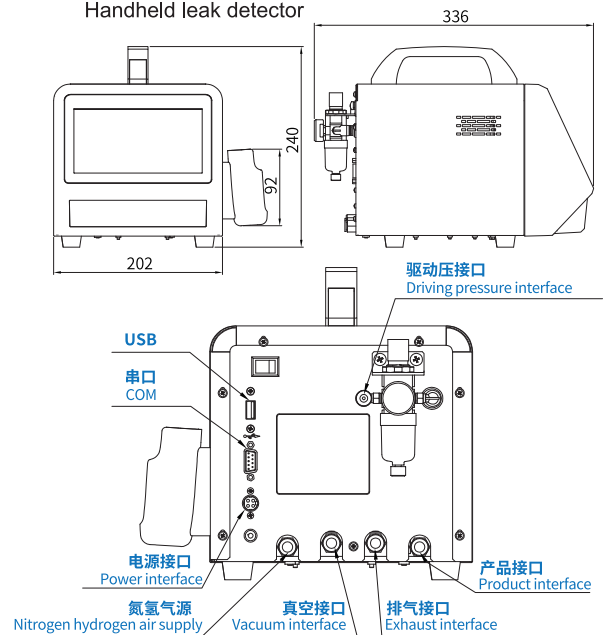

无线氮氢巡检仪 Wireless hydrogen leak detector



可用于多个测试回路同时检测的快速氮氢检漏设备。
Nitrogen-hydrogen rapid leak detection equipment can be used for simultaneous detection of multiple test loops.

- 设备可自由移动，可配备储气罐；
- 不同回路可独立实现充气、大漏检测、漏点检查、排气等过程，测试过程全自动；
- 适用于新能源汽车电池包、氢燃料电池、加氢站、氢冷机组等管路或设备的漏点查找工作。
- The equipment can be moved and can be equipped with air storage tank.
- Different loops can independently inflation, leak detection, calibration range, exhaust and other processes, the test process is automatic.
- Suitable for leak point searching of new energy vehicle battery pack, hydrogen fuel cell, hydrogenation station, hydrogen cooling unit and other pipeline or equipment.

主要产品

● 气密检漏仪

● 数字压力表

● 流量计

● 自动压力、流量控制器

● 密封性能检测专用设备

BOYIE | 天津博益气动股份有限公司
TIANJIN BOYI PNEUMATICS CO., LTD.

公司·工厂：天津开发区泰丰路80号 邮编：300457

电话：(86)22-59810966 传真：(86)22-59810963

营销中心：北京市丰台区角门18号名流未来大厦801-805室 邮编：100068

电话：(86)10-87582461 传真：(86)10-87582462

网址：www.boyiqd.com 邮箱：sales@boyiqd.com

公司在深圳、顺德、杭州、上海、苏州、长沙、武汉、重庆、西安、青岛、沈阳设有分支机构。



代理经销商



扫一扫，查看
办事处地址